

## Unit - V

### SOLUTIONS

#### *Definition :*

A solution is defined as a homogeneous mixture of two or more chemically non reacting substances. Therefore a solution forms a single phase. A solution may be gaseous, liquid or solid.

A binary solution consists of two constituents. The constituents of a solution are classified as solvent and solute. A **solvent** is that constituent which is present to a larger extent in the solution. A **solute** is that constituent which is present to a smaller extent in the solution. The following are some examples for the kinds of solutions.

#### **Types of binary solutions:**

- |                                     |  |
|-------------------------------------|--|
| i. A gas dissolved in a liquid      | Eg., CO <sub>2</sub> dissolved in water. |
| ii. A liquid dissolved in a liquid. | Eg., Alcohol in water.                   |
| iii. A solid dissolved in a liquid  | Eg., Sodium chloride in water.           |

#### **Liquid in Liquid solutions :**

The mutual solubilities of the two liquids depend upon the pressure and the temperature of the binary liquid mixture. The effect of pressure of temperature on the composition of a binary solution can be explained by the P - C or T - C phase diagram respectively.

Depending upon the mutual solubilities of the two liquids, the binary liquid systems are classified into three types :

1. Completely miscible liquid systems.
2. Partially miscible liquid systems.
3. Immiscible liquid systems.

#### **Completely miscible liquid systems :**

when two liquids are soluble in each other in all proportions, a completely miscible binary solution is formed.

Eg., : i. Benzene and toluene, ii. Alcohol and water, iii. HCl and water.

#### **Binary Ideal Solutions :**

A solution is said to be an **ideal solution** if the molecules in it attract one another with equal force irrespective of their nature. Thus if we have



an ideal solution of B in A, the forces between A and A, B and B, and A and B should be the same.

### Definition

A solution which obeys Raoult's law exactly at all concentrations and at all temperatures is known as ideal solution.

### Characteristics of an ideal solution

- i. The property of an ideal solution is the sum of the properties of the component liquids.
- ii. There is no interaction between the molecules of the components of an ideal solution.
- iii. There is no volume change of mixing for an ideal solution  $\Delta V_{\text{mix}} = 0$ .
- iv. There occurs no heat change during mixing of components  $\Delta H_{\text{mix}} = 0$
- v. Mixing of components of an ideal solution involves increase in entropy.  $\Delta S_{\text{mix}} > 0$
- vi. In an ideal solution, the activity of a component is equal to its mole fraction.
- viii. An ideal solution obeys Raoult's law.

### Examples :

- i. Benzene and toluene
- ii. Benzene and ether
- iii. Hexane and heptane
- iv. Chlorobenzene and bromobenzene

### Non-ideal solutions :

The solutions which deviate from ideal behaviour to a smaller or a greater extent is said to be non ideal solutions. For a non ideal binary solution none of the components follows Raoult's law over the entire range of concentrations. ) 2M ⊕

### Definition

A solution which does not obey Raoult's law at all concentrations and at all temperatures is known as a non - ideal solution.

- Eg. i. Acetone - Carbon di Sulphide    ii. Ethyl Alcohol - Chloroform:  
 iii. Cyclopropane - Chloroform



## Reasons for non ideal behaviour :

The reason for deviation from ideal behaviour is the fact that the molecules in the solution attract one another with unequal forces depending upon their individual nature. If we have a non ideal solution of B in A, the inter molecular forces between A and A, B and B, and A and B will not be equal.

## Raoult's law

A quantitative relationship between the vapour pressure of a liquid and its concentration in solution was deduced by Raoult. This is known as Raoult's law. According to this law.

*The partial vapour pressure of any volatile liquid in a solution is equal to the product of the vapour pressure of the pure liquid and its mole fraction in the solution.*

If an ideal solution is formed between A and B.

$$P_A = P_A^0 X_A$$

$$P_B = P_B^0 X_B$$

Where,  $P_A$  = Partial vapour pressure of A in solution

$P_A^0$  = Vapour pressure of pure A

$P_B$  = Partial vapour pressure of B in solution

$P_B^0$  = Vapour pressure of pure B

$X_A$  = Mole fraction of A in the solution.

$X_B$  = Mole fraction of B in the solution

## Deviation from Raoult's Law :

Non ideal solutions deviate from ideal behaviour. The deviation may be either **positive** or **negative** from Raoult's law. Based on the nature of deviation the non ideal binary solutions are classified into two types.

- i. Non - ideal solution showing positive deviation from Raoult's law.
- ii. Non - ideal solution showing negative deviation from Raoult's law.



**1. Non - ideal solution showing Positive deviation from Raoult's law :**

There is a weaker intermolecular forces of attraction between A and B than A - A and B - B.

In this system the individual vapour pressure curves fall well above the ideal solution line.

That is, the partial pressures are more than those calculated from Raoult's law. So this system exhibits positive deviation from Raoult's law. The Raoult's law predictions are shown by the dashed lines. The total vapour pressure shows a maximum.

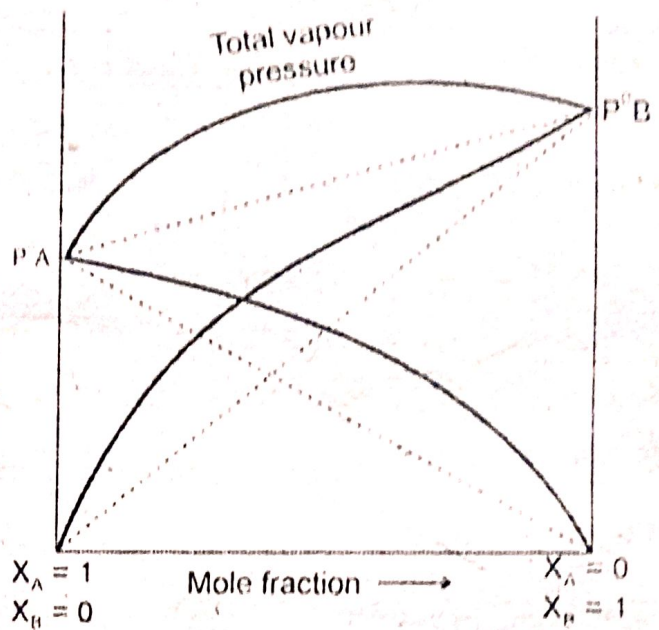

- Eg., i. Acetone - Carbon disulphide  
 ii. Ethyl alcohol - Water  
 iii. Chloroform - Ethyl alcohol

**Reason for positive deviation :**

The two liquids have different

- i. polarizability
- ii. internal pressure
- iii. molecular association
- iv. molecular structure.

**2. Non - ideal solution showing negative deviation from Raoult's law :**

In this solutions there is a greater intermolecular attraction between A and B than A - A and B - B.

In this system the vapour pressures curves fall below the Raoult's law predictions.

The system exhibits negative deviation from Raoult's law. The total vapour pressure has a minimum value which lies below the vapour pressure of either of the pure components.

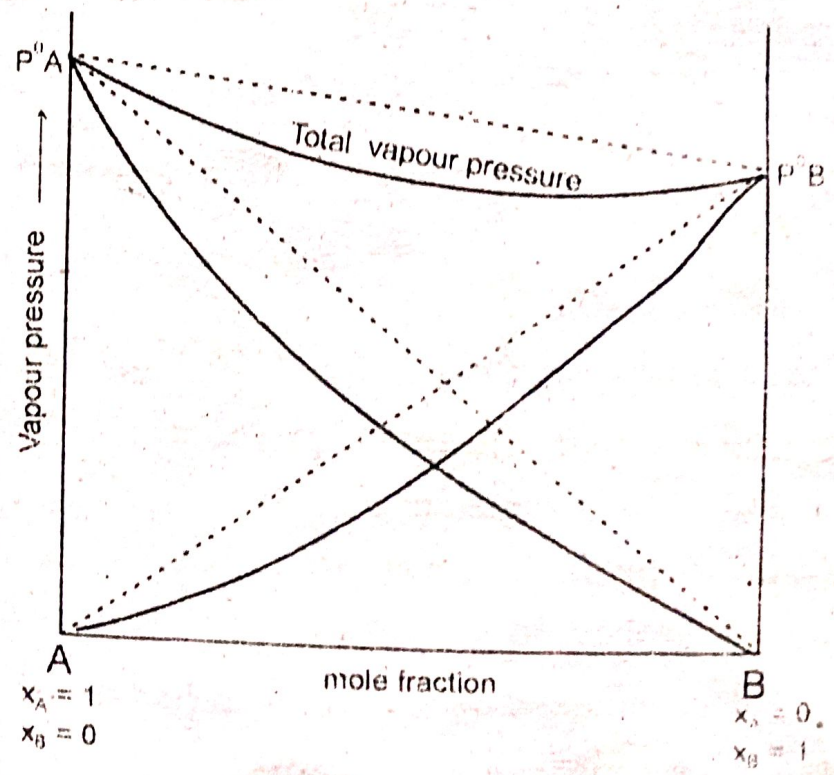



- E.g.
- i. Acetone - Chloroform
  - ii. Pyridine - Acetic acid
  - iii. Hydrochloric acid - Water.

### Reason for negative deviation :

- i. The two liquids react to form ions that cannot be evaporated.
- ii. Hydrogen bond also form in the solution.

### Vapour pressure of ideal solution :

The Vapour pressure of an ideal binary solution of two components A and B against their mole fractions are shown in the figure.  $P_A^0$  and  $P_B^0$  are the vapour pressure of pure components A and B.

The dotted lines in the figure represents plots of the partial pressure  $P_A$  and  $P_B$  of the two components. A and B respectively against their respective mole fractions. Each dotted is a straight line and passes through the origin indicating both components are ideal liquids. The solid line gives the total vapour pressure of the mixture of A and B of all compositions and is obtained by joining  $P_A^0$  and  $P_B^0$ .

It is clear from the graph that the partial pressure of each constituent against its mole fraction in the solution is a straight line and the total pressure of the solution for any given composition is equal to the sum of the partial vapour pressure of the two constituents.

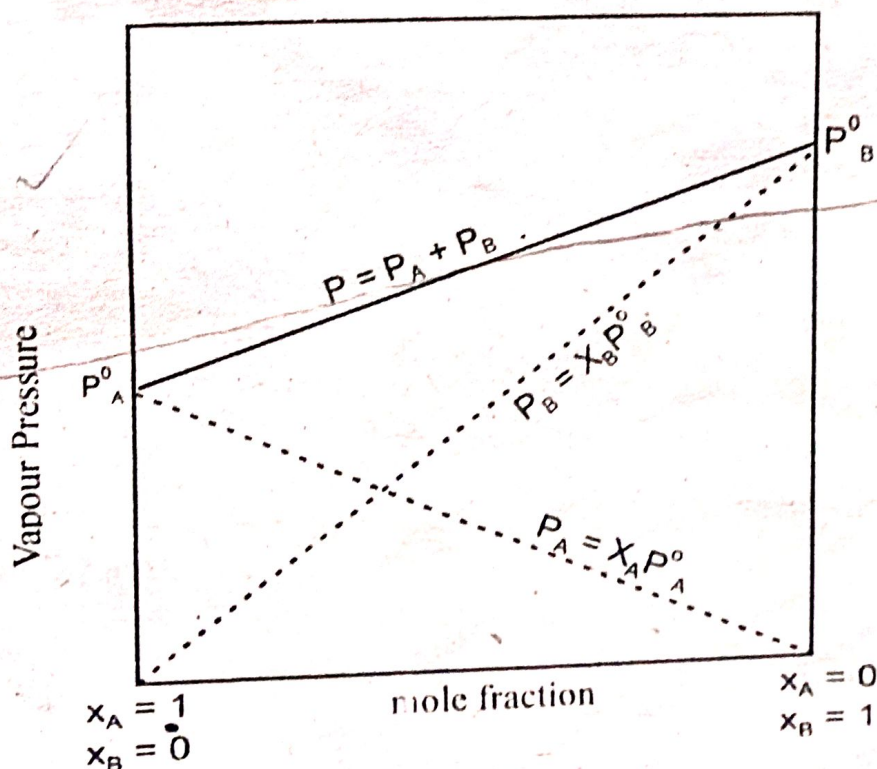



The partial vapour pressure of component A is given by  $x_A P_A^0$  and that of component B is given by  $x_B P_B^0$ . The total vapour pressure (P) of the solution is given by  $x_A P_A^0 + x_B P_B^0$ .

Eg. i. Benzene - Toluene,

ii. Cyclohexane - Carbon tetrachloride.

### Boiling point - Composition diagram for an ideal Binary solutions :

#### Principle of fractional distillation :

The components of an ideal binary liquid system can be separated by repeated step - wise distillation. The principle of this process called fractional distillation can be explained by the boiling point - composition curves of the system.

When an binary liquid mixture (AB) of composition  $x_1$  is distilled, it boils at  $t_1$ . At this temperature, the vapour in equilibrium with the solution will have the composition  $x_2$  in which the more volatile component B is in greater proportion.

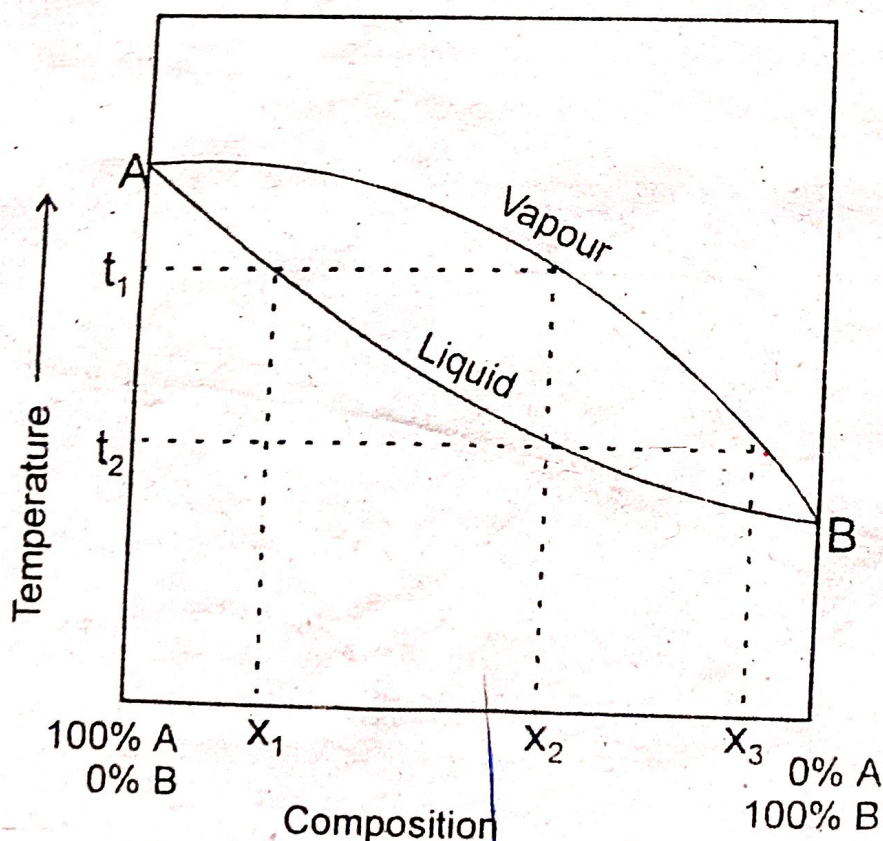



The partial vapour pressure of component A is given by  $x_A P_A^0$  and that of component B is given by  $x_B P_B^0$ . The total vapour pressure (P) of the solution is given by  $x_A P_A^0 + x_B P_B^0$ .

- Eg. i. Benzene - Toluene,  
ii. Cyclohexane - Carbon tetrachloride.

### Boiling point - Composition diagram for an ideal Binary solutions :

#### Principle of fractional distillation :

The components of an ideal binary liquid system can be separated by repeated step - wise distillation. The principle of this process called fractional distillation can be explained by the boiling point - composition curves of the system.

When an binary liquid mixture (AB) of composition  $x_1$  is distilled, it boils at  $t_1$ . At this temperature, the vapour in equilibrium with the solution will have the composition  $x_2$  in which the more volatile component B is in greater proportion.

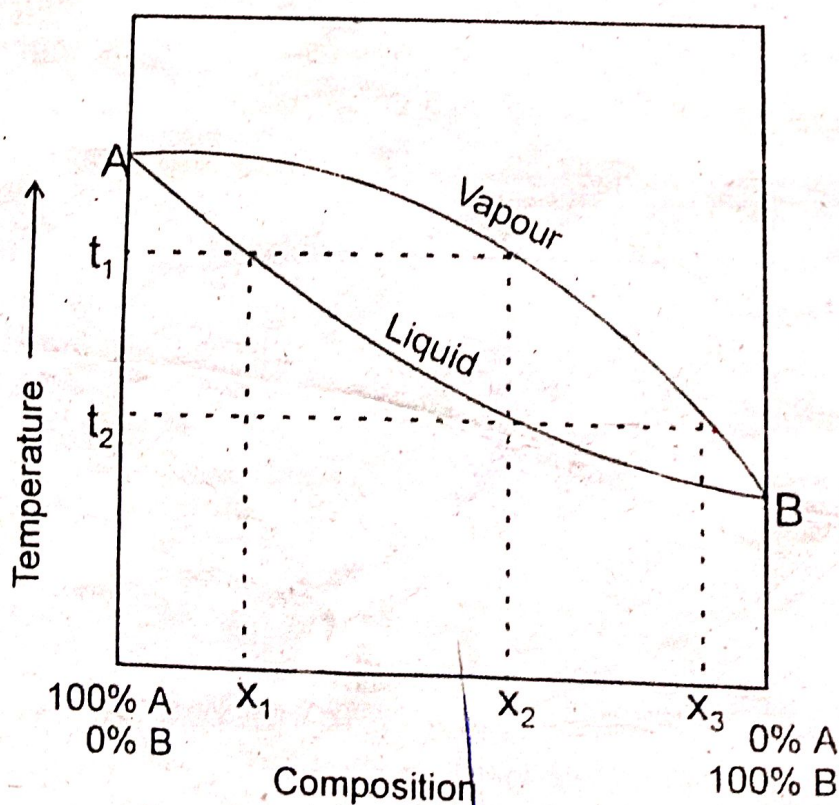



The vapour is removed and condensed. If the condensed liquid or distillate so obtained is redistilled, it will boil at  $t_2$  and the vapour in equilibrium will have the composition  $x_3$ . On removing this vapour and condensing, a second distillate is obtained. This has a greater proportion of B than the first one. If the process is repeated several times, pure B is obtained as the distillate. Consequently, the component A remains as the residual liquid. This method is used to separate ideal solutions like  
 i. Benzene and toluene ii. Benzene and ether, etc.

### **Method of fractional distillation :**

The apparatus used for the separation of mixture of ideal or non - ideal solutions is as shown in the figure.

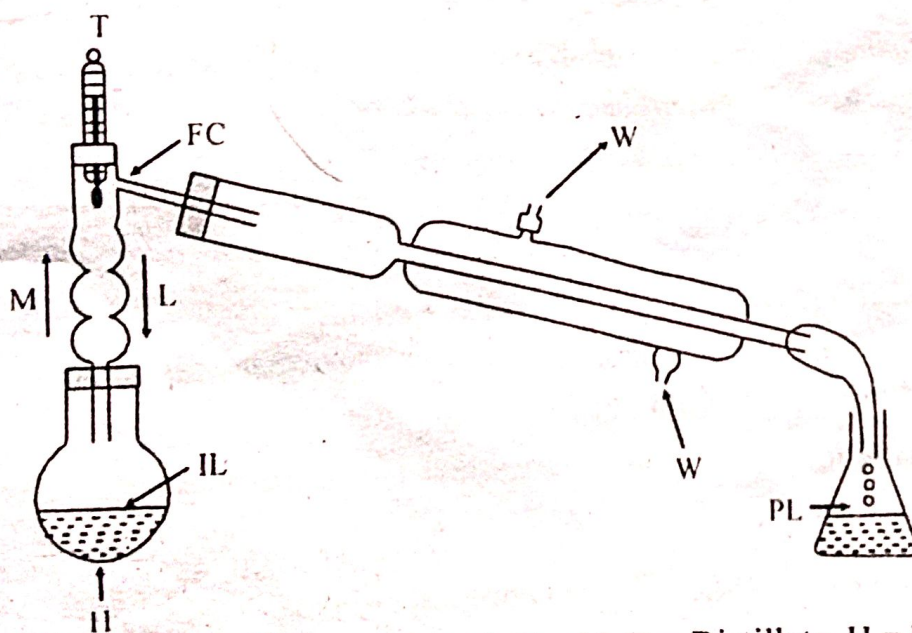

I = Impure liquid, M = More volatile liquid, D = Distillate, H = Heat,  
 L = Less volatile liquid, FC = Fractionating column, W = Water

The apparatus consists of a long tube called fractionating column containing a side tube fitted to a water condenser and a receiver. The fractionating column is fitted with a thermometer at the top and a flask containing ideal solutions at the bottom.



When the liquid mixture is heated in the flask, the vapours consisting more of the volatile component rises up and passes through the condenser and collected in the receiver. The less volatile component remains in the flask below. In this way almost complete separation is achieved for ideal solutions. But for non - ideal solutions non azcotropic mixture or constant burling mixture is obtained.

### Non ideal solutions - Azeotropes

16/8/18, Thursday

LOM  
The complete separation of the components of a non - ideal binary liquid system is not possible by fractional distillation. At best, it can be resolved into one pure component and a mixture of the two components. When the resulting mixture is heated, it distills over without any change in composition. Mixtures of this type are known as ***constant boiling mixtures or azeotropic mixtures or azeotropes.***

Fractional distillation which results in the formation of an azeotropic mixture is called ***azeotropic distillation.*** The Principle of azeotropic distillation can be understood from the boiling point - composition curves of a non ideal system.

All real solution are non-ideal because they all deviate from ideal behaviour to more or less extent. The boiling temperature - composition curves of the liquid and vapour phases of systems of positive and negative deviations from Raoult's law shows that two types of constant boiling solutions are obtained.

- i. Solutions with a minimum boiling point
- ii. Solutions with a maximum boiling point

These solutions at a minimum or a maximum boiling point is called azeotropic mixtures.



### Definition of Azeotropic mixture :

Binary mixtures of completely miscible liquids which distil without any change in composition are called constant boiling mixtures or azeotropic mixtures or azeotropes. ) 2M (10)

#### i. Solutions with a minimum boiling point

Complete separation of the two components by fractional distillation is possible only in the case of ideal solutions.

In the boiling point - composition diagram (figure - a) of a non ideal system like water - ethanol we find a minimum boiling point M. At this minimum point M, the compositions of the vapour and the solution are the same.

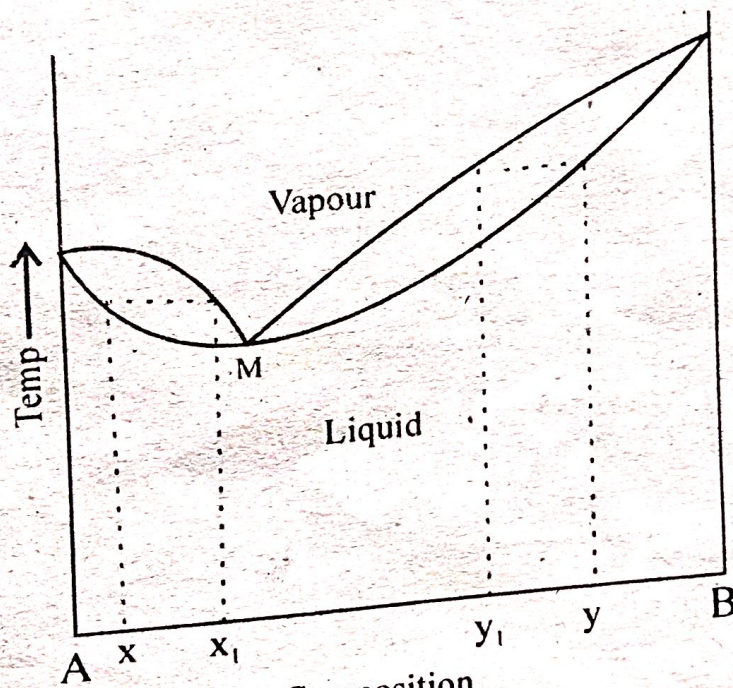

figure - a

Suppose we start the distillation at the composition x. The first fraction collected will have the composition x<sub>1</sub>. As the distillation is repeated the composition of the distillate changes towards M. Ultimately, by repeated fractional distillation the mixture with a minimum boiling point



of composition M will be obtained as distillate. Pure A will be left as residue in the distillation flask. In this case it is not possible to get pure B.

Constant boiling mixture of composition M is called azeotropic mixture in this case has a boiling point lower than any other mixture of the components A and B. The composition of the residual liquid will shift towards A.

If on the other hand a mixture of composition y is distilled, ultimately the constant boiling mixture with minimum boiling point M, is obtained. In this case it is not possible to get pure A.

Eg. : Water—ethanol system

Pure water boils at  $100^{\circ}\text{C}$  and pure ethonal boils at  $78.3^{\circ}\text{C}$  while the azeotropic mixture boils at  $78.13^{\circ}\text{C}$  under a pressure of 1 atmosphere. The composition of the azeotropic mixture is 95.6% of ethyl alcohol. If a solution containing less than 95.6% of ethyl alcohol is distilled pure water will escape and the residue ultimately will contain a mixture of the same constant composition namely 95.6% of ethyl alcohol.

The constant boiling mixture can be separated using special methods.

## ii. Solutions with a maximum boiling point

In the boiling point - composition diagram (figure - b) of a non ideal system like acetone - chloroform we find a maximum boiling point M. At this maximum point M, the compositions of the vapour and the solution are the same. This is called azeotropic mixture or constant boiling mixture.

The azeotropic mixture in this case has a boiling point higher than any other mixture of the components A and B.

E.g.,

- i. Acetone and chloroform
- ii. Water and hydrogen chloride
- iii. Water and nitric acid.



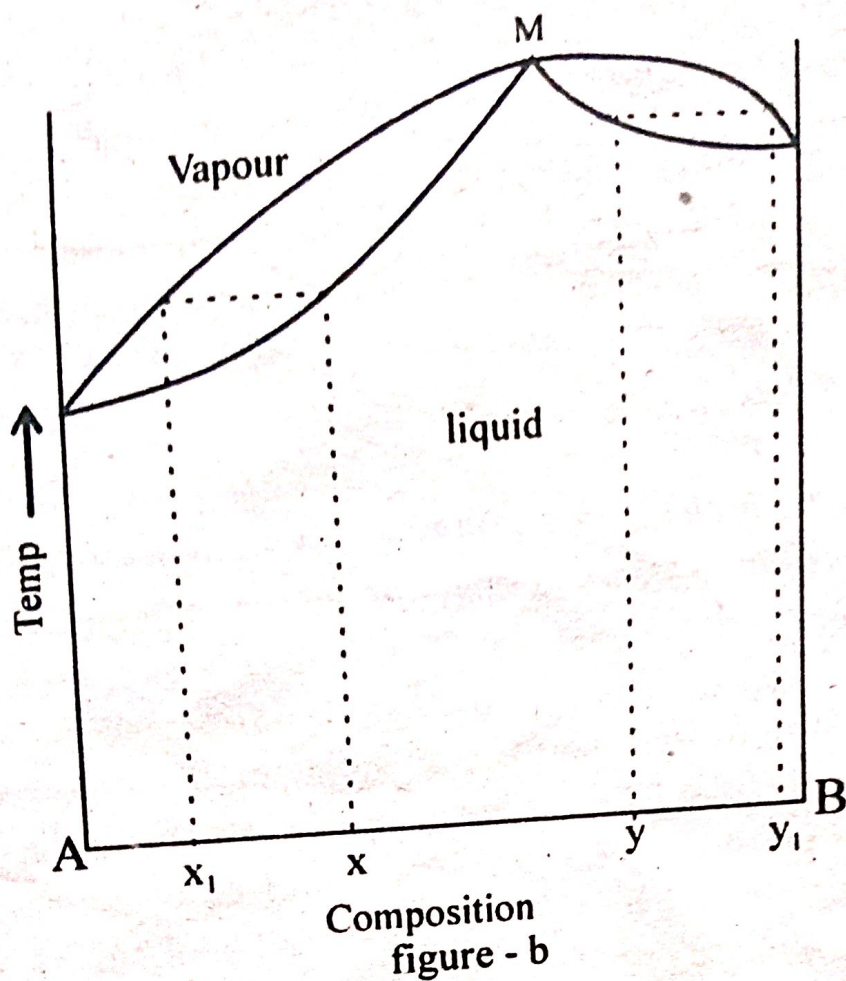

Pure water boils at  $100^{\circ}\text{C}$  and pure hydrogen chloride boils at  $-85^{\circ}\text{C}$ , while their azeotropic mixture boils at  $108.5^{\circ}$  under a pressure of 1 atmosphere. The composition of azeotropic mixture is 20.24% of HCl. If a solution containing more than 20.24% of HCl is distilled pure HCl will escape and the residue ultimately will contain a mixture of the same constant composition namely 20.24% of HCl.

These azeotropes can be separated using special methods.

#### Significance of azeotropic mixtures :

1. Azeotropic mixtures indicate that they cannot be separated by fractional distillation.
2. It indicates separate methods have to be adopted to obtain one of the components in a pure state.



16/8/18,  
Thursday

ಶ್ರೀ ಸುಧಾ ಸಿದ್ಧಾಂತ

## CHROMATOGRAPHY

②  
Chromatography is defined as an analytical technique for separating compounds on the basis of differences in their affinities for a **stationary phase** and a **mobile phase**. In all the chromatographic techniques, differences in affinities involve the process of either **adsorption or partition** and ion exchange.

### I. Column Chromatography :

#### Principle :

Column chromatography is defined as a separation process involving the uniform percolation of a liquid solute through a column packed with finely divided material. The separation in the column is effected either by direct interaction between the solute components and the surface of the stationary phase or by adsorption of solute by the stationary phase. Column chromatography involves adsorption, partition or ion exchange phenomena. In partition column chromatography, the substances are preferentially adsorbed by the adsorbent packed in the column. Components of a mixture distribute themselves in different ratios between two different solvents and thus get separated. In this method the column is packed with silica gel or cellulose which contains significant amounts of water.

#### Procedure :

##### Packing the Column :

The column can be of any size, shape and length. Usually, the column is made of thin walled pyrex glass tube which is closed with a rubber stopper. Thus powdered adsorbent is retained.

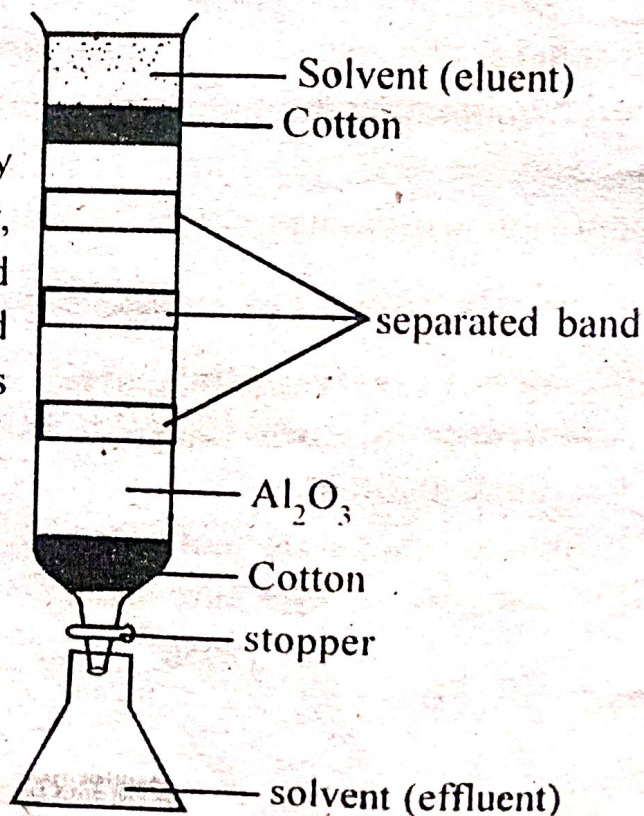



The column is packed with dry powder. Wet packing is more common. For wet packing, the column is clamped in a vertical position. A thick slurry of the adsorbent in a suitable medium is poured through the open end gradually and allowed to settle under gravity until a column of desired height is obtained. The tap at the lower end is then opened to allow the liquid to run out until it just covers the top of the medium. In the dry packing, the dry powdered adsorbent is introduced through the open end and packed carefully without any gap upto required height. Alumina or magnesia may be used as adsorbent. *silica*

In a chromatographic separation different solvents may be used for (i) placing the solute on the column (ii) developing the chromatogram and (iii) eluting the adsorbed materials. But in practice a single solvent is used for all the above said purposes. Some common solvents are ether, acetone, chloroform, alcohols and water.

### **Method of separation :**

A solution of the mixture to be separated is prepared in a relatively non-polar solvent. It is introduced into the column in a stepwise manner with the help of a pipette. The stop clock at the bottom is opened slightly to allow the solvent to run out until a small amount of the solution remains in the column covering the top of the packing material. When all the solution has been poured, the eluting solvent is then introduced. It is allowed to flow steadily through the column.

First the components of the mixture are adsorbed at the top of the column. When the eluent percolates through the column the various substances are separated. This process is known as **development**. If the components are coloured, different colour zones are got in the column. As development continues, the separation becomes more and more pronounced. This separation can be done in two ways.

- i) The eluent is passed through the column till all the zones are washed out completely. The eluted solvent is collected in a separate vessel. Different vessels are used to collect the eluted solvents for different zones
- ii) Elution is carried out till the separation is complete i.e., till we get well defined bands. Now the adsorbent with the zones is taken out. Each zone is separated with the help of a knife. Then each zone is dissolved in suitable solvent and then analysed by usual methods.



**Identification of compounds :**

Column chromatography is applicable to both coloured and colourless substances. If the substances is coloured, they are identified easily. If the substance is colourless, in practice, the eluate is analysed by usual methods. The eluent with the compound is evaporated to remove the solvent. The pure compound is isolated, and It is analysed.

**Application :**

The basic application of column chromatography is separation of mixtures into pure individual components.

**Examples :**

i. A mixture of  $Pb^{2+}$ ,  $Ag^+$ ,  $Zn^{2+}$  ions can be separated on alumina. Here the solvent is water and the eluent is water and a solution of hydrogen-sulphide. The following coloured bands are got.

- a) Lead sulphide-black at the top.
- b) Silver sulphide-grey in the middle.
- c) Zinc sulphide - dirty white near the bottom.

ii. A mixture of ferric alum and cupric sulphate can be separated on alumina. Here the solvent is water. The eluent is water. We get a blue band of  $Cu^{2+}$  below a brown band of  $Fe^{3+}$ . Now the bands are eluted with 2% solution of potassium ferrocyanide. The lower band becomes brown with the formation of cupric ferrocyanide. The upper band becomes deep blue to the presence of ferricferrocyanide.

**Paper Chromatography****Principle:**

In paper chromatography the separation of unknown materials is effected by the differential migration of different components on a specially designed filter paper. This separation occurs due to difference in partition coefficients.

It is type of partition chromatography. Here the mobile phase is an organic solvent and the stationary phase is water adsorbed on the surface of the paper. Alternatively, the paper may be impregnated with anhydrous silica, alumina or ion exchange resin. Here partition occurs as a consequence of solid-liquid, ion-exchange equilibria.



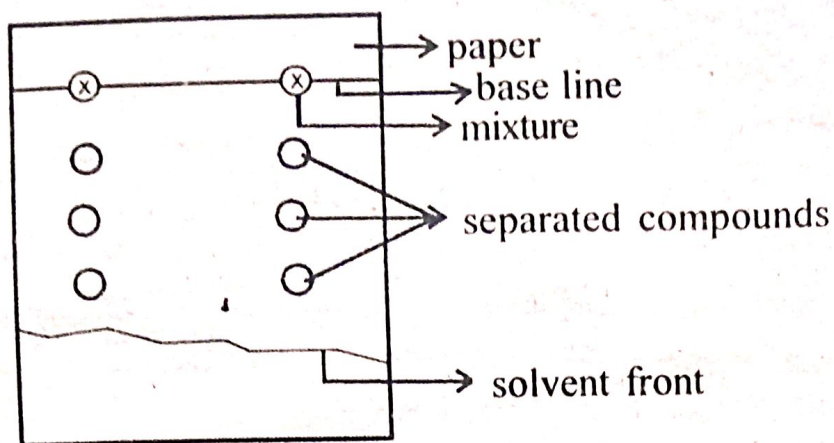

Developed Paper

Two types of forces operate when a drop of a solution is applied on the filter paper and treated with a solvent.

i. The propelling force drags the substance in the direction of the flow of solvent. At a certain temperature, different components of a mixture will dissolve differently in a given solvent. The compound with higher solubility will move rapidly along the strip of the filter paper than the less soluble one. This leads to a separation.

ii. The retarding force drags the substance behind towards its point of application. This retardation depends on the adsorption and partition. Thus, when a drop of solution is treated with the solvent on the strip of a paper the more strongly adsorbed component remains at the point of application while the less strongly adsorbed will move along the paper with the solvent. The process of partition is also operative on paper. The cellulose of the filter paper always contains a small amount of water. Partition of the substance takes place between water in the cellulose and the mobile organic solvent. This also causes separation of substance.

Thus we see that solvent and the substances move at different rates because of the above said factors. The relative rate of the movement of the solvent and solute in PC is expressed by a term  $R_f$  value.

$R_f$  value is defined as the ratio of the distance travelled by the compound to the distance travelled by the solvent. Both distances are measured from the point of application of the sample.

$$R_f = \frac{\text{Distance moved by the sample}}{\text{Distance moved by the solvent}}$$

2M (15)



140

The movement of the solvent is always greater than the solute. Therefore,  $R_f$  value is always less than 1.  $R_f$  values depend on the solvent used. So  $R_f$  value of a particular compound is given with reference to the solvent used.

### Importance of $R_f$ value :

Every compound has a characteristic  $R_f$  value. So by measuring the  $R_f$  value of a particular component in a mixture, we can identify the compound. Thus  $R_f$  values are very helpful for the qualitative analysis of mixtures by paper chromatography.

In many cases the solvent moves beyond the end of the paper. So another term  $R_x$  is used.  $R_x$  is the ratio of the distance travelled by a substance to the distance travelled by a chemically similar standard substance.

$$R_x = \frac{\text{Distance moved by the substance}}{\text{Distance moved by standard substance X}}$$

### Procedure :

A rectangular Whatman filter paper 15-30 cm in length and to several cms in width, is used in Paper chromatography.

A pencil line is drawn about 5cm from one end. This line is called the **base line**. Depending upon the number of samples to be analysed, several cross marks are made with a pencil on the line at equal distances. A drop of the concentrated solution of each sample is placed on the cross marks using a capillary pipette. The solvent is allowed to evaporate or if necessary dried quickly with an electrical drier.

The chromatogram is developed by i) the ascending technique ii) the descending technique, and iii) the radial development.

After the solvent has moved a certain distance for a certain time, the chromatogram is taken out from the tank and the position of the solvent front is marked with a pencil. The chromatogram is now dried by blowing hot air. Coloured compounds are easily located. Colourless compounds have to be located by either physical or chemical methods. The paper is cut in to pieces separately and the compounds are isolated using suitable solvents.



**Application :**

- The following separations have been effected.
- i)  $\text{Sb}^{3+}$  from other common ions. The solvent used was HCl and the chromatogram was developed with  $\text{H}_2\text{S}$ .
  - ii) Ca, Sr and Ba have been separated as chlorides using pyridine containing 4% KCNS.
  - iii) Anions have also been detected and separated. The  $R_f$  values of halides have been found to be in the following increasing order.  
 $\text{F}^- < \text{Cl}^- < \text{Br}^- < \text{I}^-$
  - iv) Matallic ions of group I, II and IV have been identified and separated.

**Thin Layer Chromatography :****Principle :**

In thin layer chromatography (TLC) some adsorbents like silica gel, alumina etc., are supported as thin layer on glass plates (now called chromatoplates). This technique is similar in some aspects to both column and paper chromatography. But in this technique we have a wider choice of the media. So we can separate compounds by partition, adsorption and ion exchange. TLC may be considered basically for qualitative identification, quantitative separation in the preparation of organic materials.

Here also, as in column chromatography, the moving substances are attracted by the polar sites on the surface on the adsorbent by electrostatic forces. This 'binding' is reversible. There is a threefold interaction between (i) the solvent and the adsorbent; (ii) the solvent and the compound; and (iii) the compound and the adsorbent. This produces good separation of components.

We can calculate  $R_f$  values for TLC also.

**Procedure :**

Square or rectangular glass plates with sizes ranging from 2.5 x 20 cm, to 20 x 20 cm are used as 'adsorbent supports' in TLC. Plastic and metal foils can also be used instead of glass plates. The most widely used adsorbent is silica gel. A thin layer of silica gel is coated on the plate and dried. A small, amount of the sample is dissolved in a small volume of a volatile solvent such as benzene, ether or ethanol. A base line is drawn,



about 2.5 cm from one edge of the plate. The samples are applied in small spots, 1 cm apart, on the base line. The solvent is evaporated. Solutions of standard substances are applied by the side of the test samples. The chromatogram is developed by ascending method. The plate is taken out and dried. The compounds are removed by usual method.

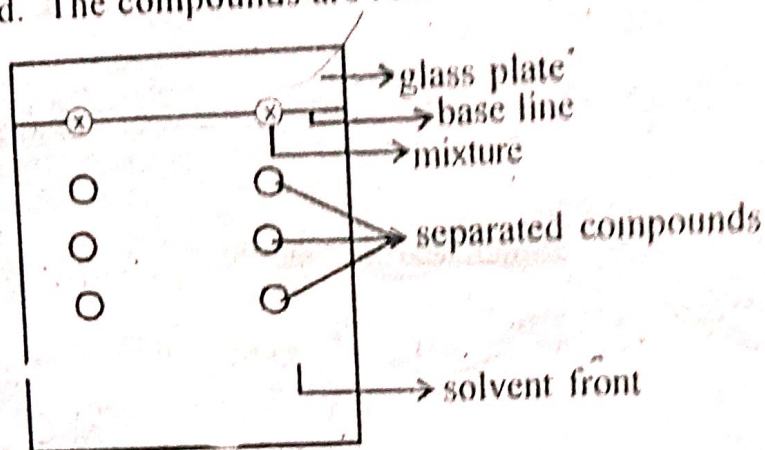

Developed glass plate

Coloured compounds can be identified by visual inspection. To identify colourless compounds, physical or chemical methods are adopted.

#### Application :

1. It is being increasingly used for qualitative, quantitative and preparative analysis.
2. The technique is extremely suited for analysis of components which are available in traces only.
3. A large number of inorganic compounds have been separated, identified and quantitatively analysed.
4. The applications of TLC include the detection of by products in synthetic processes, determination of the presence of impurity, removal of impurities.
5. Isolation of pure compounds and analysis of inorganic cations and anions. For example, Ni, Mn, Co and Zn may be separated using TLC (or PC). A mixture of acetone and hydrochloric acid is used as the solvent for development. A suitable spraying agent may be used.



### Comparison between paper and thin layer chromatography :

#### Similarities :

1. In both we can calculate the  $R_f$  values.
2. The methods of development, identification etc., are similar.

### Distinctions between paper chromatography and thin layer chromatography

<i>Paper chromatography</i>	<i>Thin layer chromatography</i>
1. Separation is based on partition.	Separation is based on partition, adsorption and ion exchange.
2. Stationary phase is water on the surface of paper	Stationary phase is some adsorbent like silica gel, alumina which are supported as thin layers on glass plates.

### University Questions

17

1. Define chromatography.
2. Describe the principle and procedure in chromatography.
3. Discuss chromatography and its applications.
4. Write a short note any one type of chromatography.
5. Give an account of column chromatography.
6. Why is column chromatography termed as elution chromatography?
7. What is the principle of paper chromatography?
8. Explain briefly paper chromatography and its applications.
9. Write two applications of paper chromatography.
10. Define  $R_f$  value. Bring out the importance of  $R_f$  value in chromatography.
11. Briefly discuss the principle and application of thin layer chromatography.
12. Why is thin layer chromatography grouped under partition chromatography?
13. Explain the application of thin layer chromatography.
14. Compare and contrast between paper and thin layer chromatography.